

NX1500

- Handheld VHF Radio -



Installation and Operation Manual
English



IN CASE OF EMERGENCY

If your vessel requires assistance, contact other vessels or the Coast Guard by sending a distress call on Channel 16.

USE CHANNEL 16!

EMERGENCY CALL PROCEDURE

- 1. MAYDAY MAYDAY MAYDAY.**
- 2. THIS IS “Name of vessel”, followed by:**
- 3. Your call sign or other indication of the vessel.**
- 4. LOCATED AT “Your location”**
- 5. The nature of the distress and assistance required.**

RECOMMENDATION

CLEAN THE TRANSCIVER THOROUGHLY WITH FRESH WATER after exposure to saltwater, air dry it before operation. Otherwise, the transceiver’s keys, switches and controllers may become inoperable due to salt crystallization.

IMPORTANT

READ ALL INSTRUCTIONS carefully and completely before using the transceiver. **SAVE THIS INSTRUCTION MANUAL**, This manual contains important operating instructions for the NX1500.

FEATURES

- **Waterproof construction**

Built to a high standard to withstand the punishing marine environment, the NX1500 meets the IPX7 standard.

- **Dual watch function**

A convenient function that allows you to monitor the distress channel (Ch 16) while receiving a second channel of your choice—dual watch.

- **Large LCD, easy-to-read**

With dimensions of 32(H) × 39(W) mm, the NX1500’s function display is easy to read and shows operating conditions at a glance. Backlight can be adjusted to suit your preference.

- **Easy-to-use**

8 large buttons on the front panel provide convenient operation. The independent volume and channel buttons are located on the front panel for convenient one-hand operation.

PRECAUTION

- **WARNING! NEVER** connect the transceiver to an AC outlet. This may create a fire hazard or result in an electric shock.
- **WARNING! NEVER** connect the transceiver direct to an AC outlet. This may create a fire hazard or result in an electric shock.
WARNING! NEVER hold the transceiver in such a way that the antenna is very close to, or touching exposed parts of the body, especially the face or eyes, while transmitting. The transceiver will perform best if the microphone is 5 to 10 cm away from the lips and the transceiver is vertical.
- **AVOID** using or placing the transceiver in direct sunlight or in areas with temperatures below -15°C or above $+55^{\circ}\text{C}$.
- **KEEP** the transceiver out of the reach of children.
- **KEEP** the transceiver at least 1 metre away from your vessel's magnetic navigation compass.
- **BE CAREFUL!** The NX1500 is built to be fully waterproof, corresponding to the IPX7 industry standard, (1 m depth for 30 min.). However, once the transceiver has been dropped, waterproofing cannot be guaranteed due to the fact that the transceiver may be cracked, or the waterproof seal may have been damaged, etc.
- **MAKE SURE** the flexible antenna and battery pack are securely attached to the transceiver, and that the antenna and battery pack are dry before attachment. Exposing the inside of the transceiver to water may result in serious damage to the transceiver.

Contents

1	OPERATION RULES	6
1.1	Priorities	6
1.2	Privacy	6
1.3	Radio licenses	6
1.3.1	Ship station license	6
1.3.2	Operator's license	6
2	INSTALLATION AND ATTACHMENTS	7
2.1	Installation	7
2.2	Accessories	7
2.3	Attachments	8
2.3.1	Flexible antenna	8
2.3.2	Hand strap	8
2.3.3	Lithium-ion battery pack	8
3	BATTERY CHARGING	9
3.1	Battery charging	9
3.2	Lithium Ion Battery Pack cautions	9
3.3	Battery duration	9
3.4	Charging connections	10
4	PANEL DESCRIPTION	11
4.1	Front, top and side panels	11
5	FUNCTION DISPLAY	13
6	BASIC OPERATION	14
6.1	Channel selection	14
6.1.1	Channel 16	14
6.2	Select country	14
6.2.1	Specific channels	15
6.2.2	Weather channels for USA and Canada	15
6.3	Normal channel selection	15
6.4	Adjusting the volume and squelch levels	15
6.5	Receiving and transmitting	16
6.5.1	Receiving	16
6.5.2	Adjust transmitter power	16
6.5.3	Transmitting	16
7	SCAN OPERATION	17
7.1	Dual watch	17
7.1.1	Description	17
7.1.2	Operation	17
7.2	SCAN types	17
7.3	Setting tag channels	18
7.4	Starting a scan	18
8	MY LIST	19
8.1	Use MY-LIST	19
9	SETUP	20
9.1	Monitor function, SQL KEY	20
9.2	Automatic backlight function	20

9.3	Automatic KEYLOCK function	21
9.4	Select country	21
9.4.1	HUNT-S channel group	22
9.5	Setup MY-LIST	23
9.6	Automatic backlight function	23
10	ADVANCED SETUP	24
10.1	LCD test.....	24
10.2	Version.....	24
10.3	Private channels	24
10.4	Reset	25
11	TROUBLE SHOOTING	26
12	SPECIFICATIONS	26
12.1	General.....	26
12.2	Transmitter.....	26
12.3	Receiver.....	27
13	DECLARATION OF CONFORMITY	28
14	CHANNEL LISTS.....	29
15	WARRANTY.....	30

1 OPERATION RULES

1.1 Priorities

- Read all rules and regulations pertaining to priorities and keep an up-to-date copy handy. Safety and distress calls take priority over all others.
- You must monitor Channel 16 when you are not operating on another channel.
- False or fraudulent distress calls are prohibited under law.

1.2 Privacy

- Information overheard but not intended for you cannot lawfully be used in any way.
- Indecent or profane language is forbidden.

1.3 Radio licenses

1.3.1 Ship station license

When your craft is equipped with a VHF FM transceiver you must be in possession of a current radio station license before using the transceiver. It is unlawful to operate a ship station which is not licensed. Inquire through your dealer or the appropriate government agency for a Ship-Radiotelephone license. This license includes the call sign that is your craft's identification for radio purposes.

1.3.2 Operator's license

A restricted Radiotelephone Operator Permit is the license most often held by small vessel radio operators when a radio is not required for safety purposes. The Restricted Radiotelephone Operator Permit must be posted near the transceiver or be kept with the operator. Only a licensed radio operator may operate a transceiver. However, non-licensed individuals may talk over a transceiver if a licensed operator starts, supervises, ends the call and makes the necessary log entries. A current copy of the applicable government rules and regulations is only required to be on hand for vessels in which a radio telephone is compulsory. However, even if you are not required to have these on hand it is your responsibility to be thoroughly acquainted with all pertinent rules and regulations.

2 INSTALLATION AND ATTACHMENTS

2.1 Installation

Follow the picture below to install a complete transceiver:

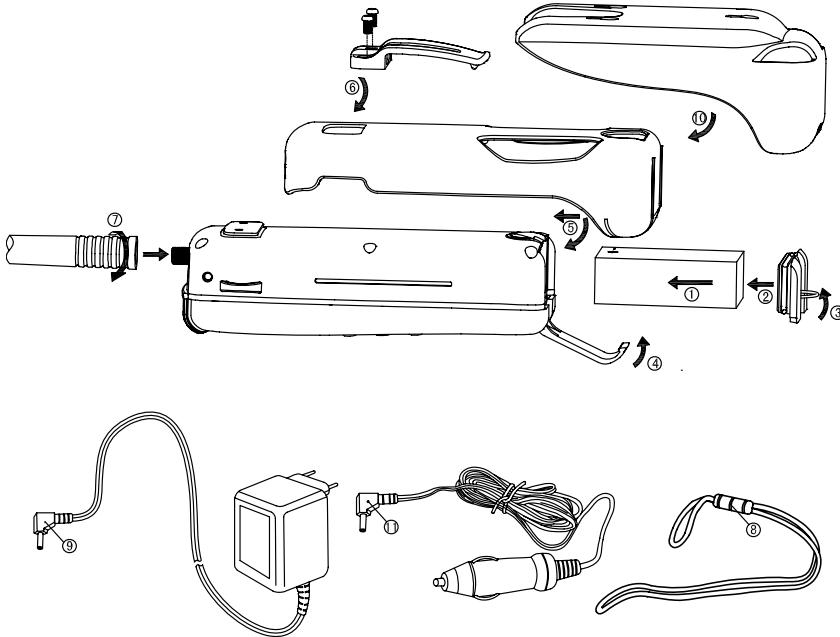

2.2 Accessories

Number	Supplied accessories	Qty.
(1)	Lithium-ion battery pack	1
(2)	Battery lid	1
(3)	Pull ring	1
(4)	Battery fixer	1
(5)	Rubber glove	1
(6)	Belt clip	1
(7)	Flexible antenna	1
(8)	Hand strap	1
(9)	AC adapter	1
(10)	Bracket	1
(11)	12Volt operation cord/charger	1

2.3 Attachments

2.3.1 Flexible antenna

Connect the supplied flexible antenna to the antenna connector.

- **NEVER HOLD** by the antenna when carrying the transceiver.
- Transmitting without an antenna may damage the transceiver.

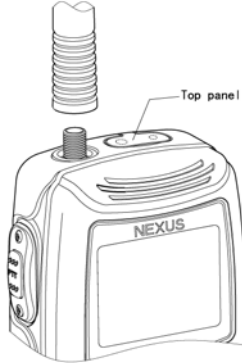

2.3.2 Hand strap

Pass the hand strap through the loop on the side of the transceiver as illustrated below for easy carrying.

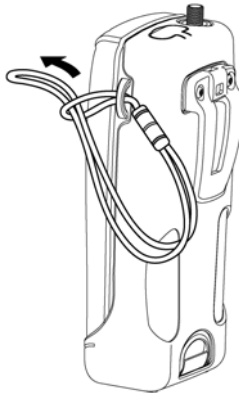

2.3.3 Lithium-ion battery pack

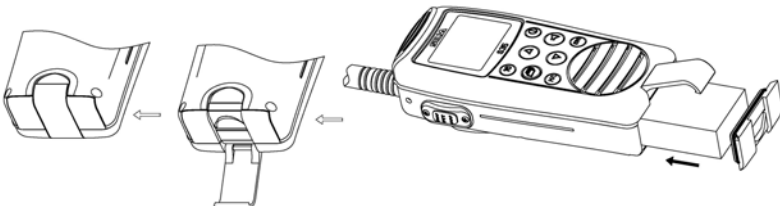

NEVER remove or insert the battery pack when the transceiver is wet or dirty. This may result in water or dust getting into the transceiver/battery pack and may result in the transceiver being damaged.

3 BATTERY CHARGING

3.1 Battery charging

Prior to using the transceiver for the first time, the battery pack must be fully charged for optimum life and operation.

- Recommended temperature range for charging: +10°C to +40°C
- Use the supplied AC adapter. **NEVER** use another manufacture's adapters.

3.2 Lithium Ion Battery Pack cautions

CAUTION!

NEVER incinerate a used battery pack. The battery may cause an explosion.

NEVER immerse batteries in water. If the battery pack becomes wet, be sure to wipe it dry BEFORE attaching it to the transceiver.

NEVER short the terminals of the battery pack.

If your battery pack seems to have no capacity even after being charged, completely discharge it by leaving the power ON overnight. Then, fully charge the battery pack again. If the batteries still do not retain a charge (or very little), new battery pack must be purchased.

Do not use chargers other than those NEXUS designated to charge the battery pack

3.3 Battery duration.

In normal operating conditions with a fully charged battery the operational duration will be 14 – 16 hours (see specification for more details).

3.4 Charging connections

1. Mount the radio in a flat and ventilated place (e.g. on a table) and install the charged battery.
2. As in the picture below, connect the adapter to a 220V power supply and the charge jack to the radio. The radio is chargeable either in power on or power off mode. During charging, the bar display will move from low to up. The bar will be static when the battery is fully charged. The radio can transmit at low power when charging with battery power ON. All the other functions are available.

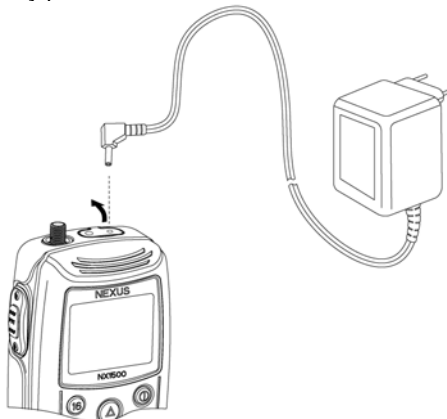

3. Charge the battery for approximately 7 hours, depending on the charge remaining in the battery at the start. .
4. When storing the radio charge the battery periodically, Do not leave with a discharged battery as this will severely curtail battery life

4 PANEL DESCRIPTION

4.1 Front, top and side panels

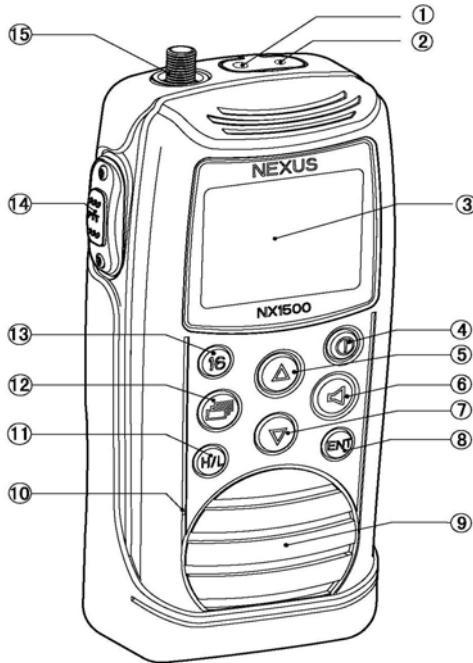

1. **External audio jack (accessory earphone, art.no 28340)**
2. **External charge jack**
3. **LCD display**
4. **POWER SWITCH/CANCEL button.** Press and hold to turn power ON and OFF. Cancel current task with a short press on this button.
5. **UP button** Select an operation channel.
6. **VOLUME and SQUELCH button** A short press on this button and the display will show a number corresponding to the **VOLUME** level that was set initially or before by the user. A second press on this button and the display will show a number corresponding to the **SQUELCH** level that was set initially or before by the user. Adjust **VOLUME** and **SQUELCH** levels with the **UP** or **DOWN** buttons. After 5 SEC (without action) the display will return to showing the main screen. Enable the MONITOR function with a long press.
7. **DOWN button.** Select an operation channel. Select a preference function in **MENU** mode. press.
8. **ENT button.** Set the current channel as a tag channel when short pressed. Clear current tag channel's tag with a second short press. Confirm a preference selection in **MENU** mode with a short press.
9. **SPEAKER**
10. **MICROPHONE**
11. **H/L button.** Used to alternate power output between 5W and 1W transmission power
12. **.MENU button.** Press **MENU** to access more functions and the preference settings. Display shows **D/WATCH**, Use **UP** or **DOWN** button to select a preference function.

Press **ENT** to confirm you selection. To exit current menu mode, press the **CANCEL** button or press the **CH16** button.

13. **CHANNEL 16 button.** Press the button for instant access to **CHANNEL 16**. This is also the "HOME" button, enabling the user to return to channel 16 from any other function. In HUNTS channels, this button enables the return to the main screen but not channel 16 when pressed.
14. **PTT button.** Push and hold to transmit; release to receive.
15. **ANTENNA CONNECTOR** Connects the supplied antenna.

5 FUNCTION DISPLAY

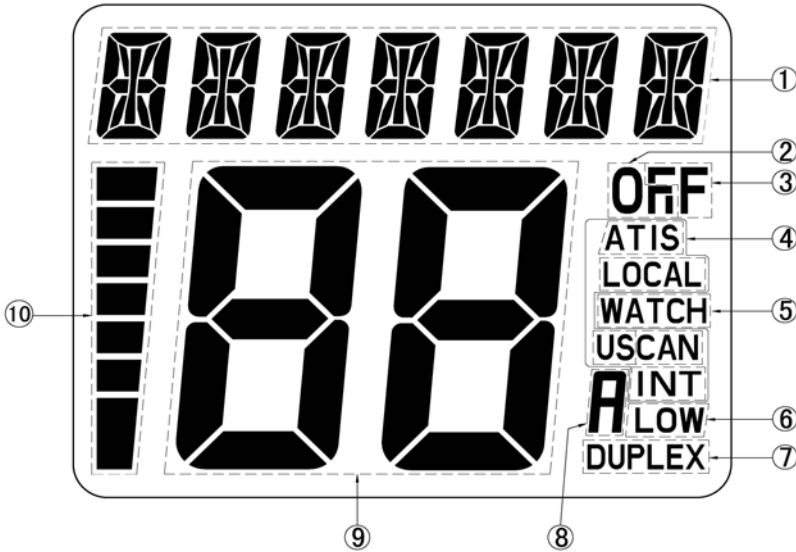

1. **TEXT AREA** All the menus or settings are displayed when it is under the menu. Also show the status of this transceiver.
2. **TAG CHANNEL INDICATOR** Appears when a tag channel is selected. In MY-LIST setting, it indicates the selected MY-LIST channel. In MY-LIST setting, it indicates the unselected MY-LIST channel.
3. **TAG – OFF INDICATOR**
4. **CHANNEL GROUP INDICATOR.** “INT” appears when International is selected; “US” appears when USA is selected; “CAN” appears when CANADA is selected; “ATIS” appears when ATIS mode is selected in NX1500 ATIS version.
5. **DUALWATCH INDICATOR** (not used in this version)
6. **LOW POWER INDICATOR.** “LOW” appears when 1W transmission power is selected.
7. **DUPLEX INDICATOR.** Appears when a duplex channel is selected.
8. **A-flag, used for US and Canadian Channels only.**
9. **CHANNEL NUMBER READOUT.** Indicates the selected operating channel number.
10. **BATTERY INDICATOR.** Indicates remaining battery power.

6 BASIC OPERATION

6.1 Channel selection

6.1.1 Channel 16

Channel 16 (the distress and hailing channel) is used for establishing initial contact with other stations and for emergency communications. Channel 16 is automatically monitored during both dual-watch. Users must monitor Channel 16 while on stand-by.

☞ Press **16** or **▲/▼** to select Channel 16, LCD will be displayed as below:



Channel 16

6.2 Select country

Your NX1500 can be set up for your country. Most countries use the international list but some countries have a specific country list (channel group). These are: US, Canada, UK, Sweden, Norway and Finland.

These channel groups can be specified for an operating area. You may violate local laws by using the wrong country setting! To use this function, take the following steps:

☞ Step 1

Press **☰** to enter main menu. Use the **▲/▼** buttons to select **SETUP** function and LCD displayed as **Figure 1**.

☞ Step 2

Press **ENT** to enter **SETUP** menu. Use **▲/▼** button to select **COUNTRY** function and LCD displayed as **Figure 2**.



Figure 1



Figure 2

☞ Step 3

Press **ENT** to enter **COUNTRY** menu. Use the **▲/▼** buttons to select a preferred **channel group/country**, the LCD shows text at top. Press **ENT** to confirm which **channel group/country** is selected.

For more information, see 9.4

6.2.1 Specific channels

UK M1 and M2 channels or Scandinavian L1 and L2 channels.

These appear between channels 88 and 01 when the U.K. channel group is selected. The LCD will show UK M at top with C1 or C2 on main screen.

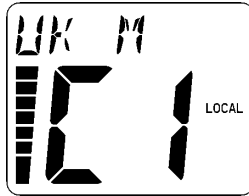

U.K. M1



U.K. M2

6.2.2 Weather channels for USA and Canada

These appear between channels 88 and 01 when the USA or Canada channel group is selected. The LCD will show USA WX or CAN WX at top.

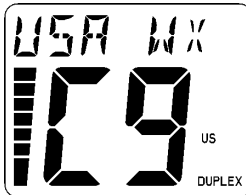

Weather channels for USA

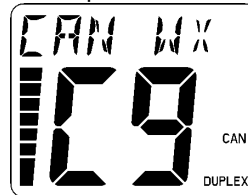

Weather channels for Canada

6.3 Normal channel selection

Press to select the operating channel. Each press on selects the next higher channel number. Each presses on selects the next lower channel number. When the key is held down, the channel changes at the rate of 12 channels per second.

6.4 Adjusting the volume and squelch levels

Press to access volume control mode. "VOLUME" will appear at the top of LCD. The volume level displays on the main screen. In volume control mode, press will access SQUELCH control mode. Press will access SQUELCH control mode. Press again and it will toggle between VOLUME and SQUELCH control mode. In SQUELCH control mode, "SQUELCH" appears at the top of the LCD, and the figure indicating the squelch level is displayed on the main screen. In the two modes if no operation is made within 5 seconds it will return to the main screen where pressing will adjust the levels of VOLUME and SQUELCH.



VOLUME Control



SQUELCH Control

6.5 Receiving and transmitting

Turn on the radio and set the VOLUME and SQUELCH at suitable levels.

6.5.1 Receiving

When radio is receiving signals, "BUSY" appears at the top of the LCD..



Receiving

6.5.2 Adjust transmitter power

According to the regulations, some channels only have high power, some channels only have low power and some channels offer the choice of either high power or low power. If selected channel has both high and low power, to switch between high power and low power, press **H/L**. It will save power if low power is selected, but the communication range will extend if high power is selected.

6.5.3 Transmitting

Press and hold the PTT when transmitting and speak into the MICROPHONE. If the current selected channel is at high power, "TX HIGH" will appear at the top of LCD; instead, "TX LOW" will appear if it is at low power. Release the PTT returns the transceiver to at receiving mode.



High Power Transmitting



Low Power Transmitting

IMPORTANT: To maximize the readability of your transmitted signal, pause a few seconds after pushing [PTT], hold the microphone 5 to 10 cm from your mouth and speak into the microphone at a normal voice level.





7 SCAN OPERATION

7.1 Dual watch

7.1.1 Description

Dual watch monitors Channel 16 while you are receiving another channel. If a signal is received on Channel 16, dual watch pauses on Channel 16 until the signal disappears.

7.1.2 Operation

Select the channel you want to use for dual watch. Press  (and you will get into the menu) the display shows D/WATCH. Press  and the radio will watch the selected channel together with channel 16. Press  or  or  to cancel D/WATCH function.

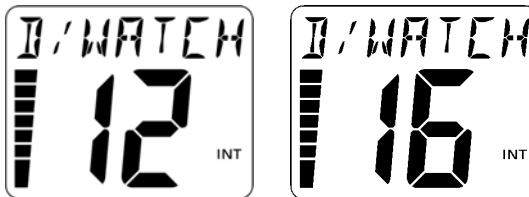

Dual Watch

7.2 SCAN types

Scanning is an efficient way to locate signals quickly over a wide frequency range. The transceiver has **Priority scan** and **Tag scan**. Set the tag channels (specific channels to be scanned) before scanning. In priority scan, Channel 16 is scanned between all other selected channels. When a signal is detected on Channel 16, the scan pauses until the signal disappears; In Tag scan, the list is scanned in sequence as it is programmed, including channel 16 if selected. If channel 16 is excluded as a TAG channel, it will not be scanned! When a signal is detected on a scanned Channel, the scan again pauses until the signal disappears.

7.3 Setting tag channels

For more efficient scanning, add desired channels as tag channels or clear the tag for unwanted channels. Non-tag channels will be skipped during scanning. Tag channels can be assigned to each channel group (INT, USA, etc.) independently. To set a tag, go to any channel in normal operation mode and give a short press on the **ENT** button.

The **On** flag will be shown on the display; the text **STORING** is displayed for 2 seconds to confirm that the selected channel is stored. To delete the flag, repeat the short press

on the **ENT** button . To clear all the tag channels, access the main menu, select CLR TAG, and then press **ENT** to confirm.



7.4 Starting a scan

Priority scan In main menu, select P/SCAN by pressing **▲** **▼** and press **ENT** to confirm, The Priority Scan is activated, stop it by pressing **⏏**, **16** or **ENT**.

Tag scan In main menu, the Tag Scan can be activated by pressing **▲** **▼** to select T/ SCAN and pressing **ENT** to confirm, stop it by pressing **⏏**, **16** or **ENT**.

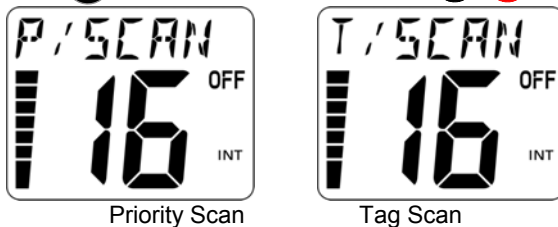

8 MY LIST





8.1 Use MY-LIST

The MY-LIST function allows users to personalize the channel list in order to get a more convenient channel operation.

In MY-LIST, the user can block channels that seldom or never are used. In this way, the list of channels will be much easier and faster to browse through.

In normal operation mode a press on  and  together will toggle between **MY LIST** and the full channel list.





You may also select MY-LIST in the main menu:





Press  to access the main menu, select MY-LIST by pressing / 
and press  to access MY-LIST

To setup MY-LIST, see 9.5

9 SETUP

9.1 Monitor function, SQL KEY







A long press on  button (**2 seconds**) will allow voice reception of weak signals by temporarily disconnecting the squelch function. Press on any button except button **16** to cancel the MONITOR function. The MONITOR function has an automatic cancellation function. Press  to access main menu, and select SETUP by pressing  .

Then press  to confirm and enter SETUP. In SETUP, select SQL KEY by pressing   and press  to confirm, and then enter SQL KEY list. There are three options in the list: OFF, 5 SEC and 10 SEC. If OFF is selected, the MONITOR function will not work. Once the MONITOR function is activated, it can be cancelled manually by pressing any button except CH16.



Monitor

9.2 Automatic backlight function

This function is convenient for night time operation. Pressing any key, will activate the backlight. To set backlight timeout Press  to access main menu, and select SETUP by pressing   and press  to confirm. Then select LIGHT by pressing   in SETUP. Press  to enter LIGHT list. There are five options in the list: OFF, 5 SEC, 10 SEC, and 20 SEC and ON. There is no backlight if "OFF" is selected. The backlight illuminates all the time if "ON" is selected. The other three options determine for how long the backlight will be illuminated.

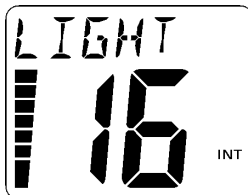

Backlight setting

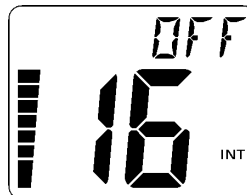

Turn off backlight

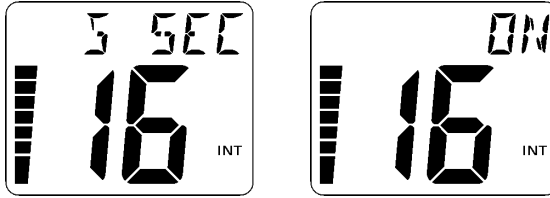

Backlight lasts for 5SEC Turn on backlight

9.3 Automatic KEYLOCK function

This function will lock the keys automatically. Press to access the main menu and enter SETUP by selecting and pressing . In SETUP, select KEYLOCK by pressing and press to access the KEYLOCK list. There are three options in the list: OFF, 5SEC and 10SEC. If select OFF, the key lock function doesn't work. If select 5SEC or 10SEC, the keys lock if no operation is made in 5SEC or 10 SEC.. Then the following screen will appear when any key is pressed. Press and hold for 3 seconds.



Locked How to unlock Unlocked

9.4 Select country

These channel groups can be specified for an operating area. You may violate local laws by using the wrong country setting! To use this function, take the following steps:

Step 1

Press to enter main menu. Use the buttons to select **SETUP** function and LCD displayed as **Figure 1**.

Step 2

Press to enter **SETUP** menu. Use button to select **COUNTRY** function and LCD displayed as **Figure 2**.



Figure 1



Figure 2

Step 3

Press **ENT** to enter **COUNTRY** menu. Use the **▲**/**▼** buttons to select a preferred **channel group**, the LCD shows text at top with small symbols on the side as shown in the figures below. Press **ENT** to confirm which **channel group** is selected.

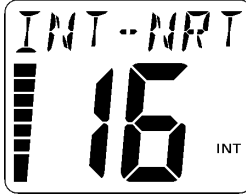

International channels

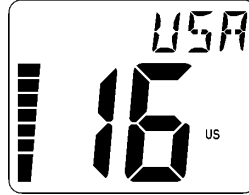

U.S.A channels

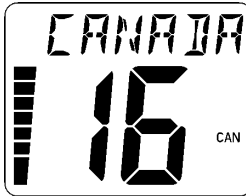

Canada channels

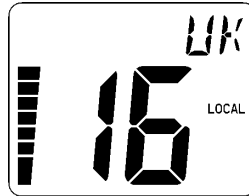

U.K. channels

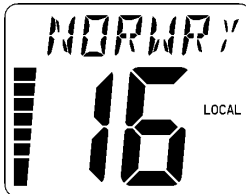

Norway channels

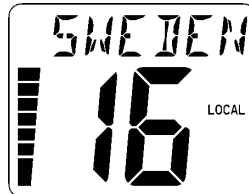

Sweden channels



Finland channels

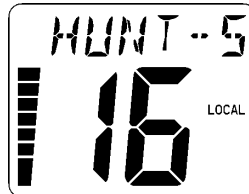



HUNT-S channels





9.4.1 HUNT-S channel group





When the HUNT-S is selected only four channels are available H1 to H4 (the four hunting channels in Scandinavia). The radio will have the same functionality as in all other modes with the exception that it will not jump to channel 16 when the **16** button is pressed.

NOTE: IN HUNT-S MODE, channel tag, SCAN AND DUAL-WATCH ARE ALL UNAVAILABLE.

9.5 Setup MY-LIST

Press  to access main menu, and select SETUP by pressing  .

Then press  to confirm and enter SETUP. In SETUP, select MY-LIST by pressing   and press  to confirm.







In MY-LIST, press   to select channels and press  to select the channel “ON” will appear when a channel is selected. “OFF” will appear when a channel is unselected. After setting all the MY-LIST channels, press  to confirm the selection.



Note 1: Channel 16 can not be excluded from MY-LIST!

Note 2: Private channels (P0 to P9) will not appear in this list. However the local channels like L1 and L2 will appear.

9.6 Automatic backlight function

This function is convenient for night time operation. Pressing any key, will activate the backlight. To set backlight timeout Press  to access main menu, and select SETUP by pressing   and press  to confirm. Then select LIGHT by pressing   in SETUP. Press  to enter LIGHT list. There are five options in the list: OFF, 5 SEC, 10 SEC, and 20 SEC and ON. There is no backlight if “OFF” is selected. The backlight illuminates all the time if “ON” is selected. The other three options determine for how long the backlight will be illuminated.

10 ADVANCED SETUP

To enter the ADVANCED SETUP, press  and  together.

To return to normal mode, press .



10.1 LCD test

Enter the ADVANCED SETUP, by pressing  and  together.

Select the LCD test by pressing  or . Then press  to confirm and enter the LCD test.

The NX1500 will now light all LCD segments in groups. This is mainly a service function.

10.2 Version

Enter the ADVANCED SETUP, by pressing  and  together.

Select the VERSION by pressing  or . Then press  to confirm.

The NX1500 will now show the NX1500 Hardware and Software number.





10.3 Private channels

The NX1500 can be programmed with private channels (channels that are not found in the selected Channel group. There are possibilities to set 10 private channels (P0 to P9)

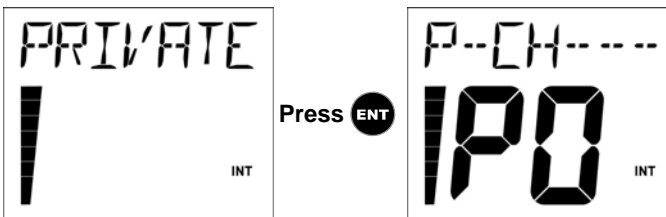
Enter the ADVANCED SETUP, by pressing  and  together.

Select the PRIVATE by pressing  or . Then press  to confirm and enter.





Select which private channel place you want to program with  or  and confirm with . The three dashes for channel selection will start to flash. Select the channel number you want to store into the private channel place with  or .

For the full channel list, see the channel list document.

10.4 Reset

The RESET function will restore the NX1500 to factory setting.

Enter the ADVANCED SETUP, by pressing  and  together.

Select the VERSION by pressing  or . Then press  to confirm.

You will then be asked if you are sure. To confirm, press , or cancel with the ON/OFF- button

11 TROUBLE SHOOTING

Problem	Possible Cause	Solution
The transceiver does not turn ON.	1. The battery is exhausted. 2. Bad connection to the battery pack.	1. Recharge the battery pack. 2. Check the connection to the transceiver.
No sound from speaker.	1. Squelch level is too deep. 2. Volume level is too low. 3. Speaker has been exposed to water.	1. Set squelch to the threshold point. 2. Set volume to a suitable level. 3. Drain water from the speaker.
Scan does not start.	• "TAG" channels are not programmed.	• Set the desired channels as "TAG" channels.
The displayed channel cannot be changed.	• Automatic keypad Lock function is activated.	• Refer to Automatic Keypad Lock function to unlock the keys
The transceiver returns to receiving mode during a long transmission.	The transmission time limit function is activated.	Release the PTT, and re-push to talk.

12 SPECIFICATIONS

12.1 General

- Frequency coverage: Transmit 156.025-161.425 MHz
Receive 156.025-163.275 MHz
 - Mode: FM (16K0G3E)
 - Channel spacing: 25 kHz
 - Current drain (at 7.4 V DC): TX at 5 W 1.3A typical
TX at 1 W 0.6 A typical
Max. Audio 200 mA typical
Power save 20 mA typical
 - Frequency stability: ± 1.5 kHz (-15°C to $+55^{\circ}\text{C}$)
 - Useable temperature range: -15°C to $+55^{\circ}\text{C}$
 - Dimensions: 60(W) \times 136(H) \times 37(D) mm
(Projections not included)
 - Weight (approx.; with Battery): 360 g
- Battery life (full charged) 14-16 hours – Based on duty cycle 90% Standby,5% Receive, 5% Transmit (full power).

12.2 Transmitter

- Output power (at 7.4 V DC): max. 5 W (Hi), max. 1 W (Low)
- Modulation system: Variable reactance frequency modulation
- Adjacent channel power: 70 dB
- Spurious emissions: Less than 0.25 μW
- Frequency Deviation: 5 KHz max peak
- Audio Frequency Response: +1, -3dB of +6dB/octave
De-emphasis 300-3000Hz

12.3 Receiver

- Receive system: Double-conversion super-heterodyne
- IF Frequency Used: 21.7MHz; 450 KHz
- Sensitivity (20 dB SINAD): +6 dB μ EMF (typical)
- Squelch sensitivity (at threshold): 0 dB μ EMF (typical)
- Inter-modulation rejection ratio: 68 dB
- Spurious response rejection ratio: 70 dB
- Adjacent channel selectivity: 70 dB
- Audio Frequency Response: +1, -3dB of +6dB/octave
De-emphasis 300-3000Hz
- Audio output power: 0.3 W at 10% distortion with An 8 Ω load

**All stated specifications are subject to change without notice or obligation.
Specifications are measured in accordance with EN 301-178-1/2, EN 301 843-1/2,
IEC 60215**

13 DECLARATION OF CONFORMITY

Declaration Of Conformity

Nexus Marine AB
P.O. Box 998
S19129 Sollentuna
Sweden

Hereby confirms that this VHF Radio conforms to the essential requirements of the Radio and Telecommunications Terminal Equipment Directive 1999/5/EC and that all appropriate test suite measurements have been performed.

Equipment: **Marine Handheld VHF Transceiver**

Type-designation: **NX1500**

This compliance is based on conformity with the following harmonised standards, specifications or documents:

Standards No: EN 307 708
EN 301 843
IEC 60215

Statement No: G103354U

CE 0678 0

Tony Kent
Chief Operating Officer
Nexus Marine AB

14 CHANNEL LISTS

The channels are listed in the separate channel list document

15 WARRANTY

WARRANTY

GENERAL

All our products are designed and built to comply to the highest class industry standards. If the products are correctly installed, maintained and operated, as described in the installation and operation manual, they will provide long and reliable service. Our international Network of distributors can provide you with the information and assistance you may require virtually anywhere in the world.

Please read through and fill in this warranty card and send it to your national distributor for product registration.

LIMITED WARRANTY

The warranty covers repair of defective parts due to faulty Manufacturing and includes labour when repaired in the country of purchase. The warranty period is stated in the product manual, and commences from the date of purchase. The above warranty is the Manufacturer's only warranty and no other terms, expressed or implied, will apply. The Manufacturer specifically excludes the implied warranty of merchantability and fitness for a particular purpose.

CONDITIONS

- The supplied warranty card and receipt with proof of purchase date, must be shown to validate any warranty claim. Claims are to be made in accordance with the claims procedure outlined below.
- The warranty is non-transferrable and extends only to the original purchaser.
- The warranty does not apply to Products from which serial numbers have been removed, faulty installation or incorrect fusing, to conditions resulting from improper use, external causes, including service or modifications not performed by the Manufacturer or by its national distributors, or operation outside the environmental parameters specified for the Product.
- The Manufacturer will not compensate for consequential damage caused directly or indirectly by the malfunction of its equipment. The Manufacturer is not liable for any personal damage caused as a consequence of using its equipment.
- The Manufacturer, its national distributors or dealers are not liable for charges arising from sea trials, installation surveys or visits to the boat to attend to the equipment, whether under warranty or not. The right is reserved to charge for such services at an appropriate rate.
- The Manufacturer reserves the right to replace any products returned for repair, within the warranty period, with the nearest equivalent, if repair within a reasonable time period should not be possible.
- The terms and conditions of the warranty as described do not affect your statutory rights.

CLAIMS PROCEDURE

Equipment should be returned to the national distributor, or one of its appointed dealers, in the country where it was originally purchased. Valid claims will then be serviced and returned to the sender free of charge.

Alternatively, if the equipment is being used away from the country of purchase, it may be returned to the national distributor, or one of its appointed dealers, in the country where it is being used. In this case valid claims will cover parts only. Labour and return postage will be invoiced to the sender at an appropriate rate.

DISCLAIMER

Common sense must be used at all times when navigating and the Manufacturer's navigation equipment should only be considered as aids to navigation.

The Manufacturer's policy of continuous improvement may result in changes to product specification without prior notice.

File id: <input style="width: 80px;" type="text"/>										
WARRANTY CARD										
TO BE RETURNED TO YOUR NATIONAL DISTRIBUTOR										
OWNER:										
Name: _____										
Street : _____										
City/Zip Code : _____										
Country: _____										
Product name:			Serial number:							
_____	A	B	C	1	2	3	4	5	6	7
_____	<input type="checkbox"/>	<input type="checkbox"/>	<input type="checkbox"/>	<input type="checkbox"/>	<input type="checkbox"/>	<input type="checkbox"/>	<input type="checkbox"/>	<input type="checkbox"/>	<input type="checkbox"/>	<input type="checkbox"/>
_____	<input type="checkbox"/>	<input type="checkbox"/>	<input type="checkbox"/>	<input type="checkbox"/>	<input type="checkbox"/>	<input type="checkbox"/>	<input type="checkbox"/>	<input type="checkbox"/>	<input type="checkbox"/>	<input type="checkbox"/>
_____	<input type="checkbox"/>	<input type="checkbox"/>	<input type="checkbox"/>	<input type="checkbox"/>	<input type="checkbox"/>	<input type="checkbox"/>	<input type="checkbox"/>	<input type="checkbox"/>	<input type="checkbox"/>	<input type="checkbox"/>
_____	<input type="checkbox"/>	<input type="checkbox"/>	<input type="checkbox"/>	<input type="checkbox"/>	<input type="checkbox"/>	<input type="checkbox"/>	<input type="checkbox"/>	<input type="checkbox"/>	<input type="checkbox"/>	<input type="checkbox"/>
_____	<input type="checkbox"/>	<input type="checkbox"/>	<input type="checkbox"/>	<input type="checkbox"/>	<input type="checkbox"/>	<input type="checkbox"/>	<input type="checkbox"/>	<input type="checkbox"/>	<input type="checkbox"/>	<input type="checkbox"/>
_____	<input type="checkbox"/>	<input type="checkbox"/>	<input type="checkbox"/>	<input type="checkbox"/>	<input type="checkbox"/>	<input type="checkbox"/>	<input type="checkbox"/>	<input type="checkbox"/>	<input type="checkbox"/>	<input type="checkbox"/>
Date of purchase: _____			Date installed: _____							
Dealers stamp:										
<input type="checkbox"/> Tick here if you do not wish to receive news about future products										

CE 0678 Ⓢ

This equipment is intended for use in:

AUT	√	EST	√	HUN	√	LUX	√	SLA	√
BEL	√	FIN	√	IRL	√	MAL	√	SLE	√
CZR	√	FRA	√	ITA	√	NET	√	SPN	√
CYS	√	GER	√	LAT	√	POL	√	SWE	√
DEN	√	GRE	√	LIT	√	POR	√	UK	√

√Countries of use



Copyright ©:

Nexus Marine AB

Kuskvägen 4, 191 62 Sollentuna, Sweden

Tel: +46 -(0) 8 – 506 939 00. Fax: +46 -(0) 8 -506 939 01

www.nexusmarine.se